



## **Cisco Firepower 1100 Series Hardware Installation Guide**

**First Published:** 2019-06-13

**Last Modified:** 2022-10-11

### **Americas Headquarters**

Cisco Systems, Inc.  
170 West Tasman Drive  
San Jose, CA 95134-1706  
USA  
<https://www.cisco.com>  
Tel: 408 526-4000  
800 553-NETS (6387)  
Fax: 408 527-0883

THE SPECIFICATIONS AND INFORMATION REGARDING THE PRODUCTS IN THIS MANUAL ARE SUBJECT TO CHANGE WITHOUT NOTICE. ALL STATEMENTS, INFORMATION, AND RECOMMENDATIONS IN THIS MANUAL ARE BELIEVED TO BE ACCURATE BUT ARE PRESENTED WITHOUT WARRANTY OF ANY KIND, EXPRESS OR IMPLIED. USERS MUST TAKE FULL RESPONSIBILITY FOR THEIR APPLICATION OF ANY PRODUCTS.

THE SOFTWARE LICENSE AND LIMITED WARRANTY FOR THE ACCOMPANYING PRODUCT ARE SET FORTH IN THE INFORMATION PACKET THAT SHIPPED WITH THE PRODUCT AND ARE INCORPORATED HEREIN BY THIS REFERENCE. IF YOU ARE UNABLE TO LOCATE THE SOFTWARE LICENSE OR LIMITED WARRANTY, CONTACT YOUR CISCO REPRESENTATIVE FOR A COPY.

The Cisco implementation of TCP header compression is an adaptation of a program developed by the University of California, Berkeley (UCB) as part of UCB's public domain version of the UNIX operating system. All rights reserved. Copyright © 1981, Regents of the University of California.

NOTWITHSTANDING ANY OTHER WARRANTY HEREIN, ALL DOCUMENT FILES AND SOFTWARE OF THESE SUPPLIERS ARE PROVIDED "AS IS" WITH ALL FAULTS. CISCO AND THE ABOVE-NAMED SUPPLIERS DISCLAIM ALL WARRANTIES, EXPRESSED OR IMPLIED, INCLUDING, WITHOUT LIMITATION, THOSE OF MERCHANTABILITY, FITNESS FOR A PARTICULAR PURPOSE AND NON-INFRINGEMENT OR ARISING FROM A COURSE OF DEALING, USAGE, OR TRADE PRACTICE.

IN NO EVENT SHALL CISCO OR ITS SUPPLIERS BE LIABLE FOR ANY INDIRECT, SPECIAL, CONSEQUENTIAL, OR INCIDENTAL DAMAGES, INCLUDING, WITHOUT LIMITATION, LOST PROFITS OR LOSS OR DAMAGE TO DATA ARISING OUT OF THE USE OR INABILITY TO USE THIS MANUAL, EVEN IF CISCO OR ITS SUPPLIERS HAVE BEEN ADVISED OF THE POSSIBILITY OF SUCH DAMAGES.

Any Internet Protocol (IP) addresses and phone numbers used in this document are not intended to be actual addresses and phone numbers. Any examples, command display output, network topology diagrams, and other figures included in the document are shown for illustrative purposes only. Any use of actual IP addresses or phone numbers in illustrative content is unintentional and coincidental.

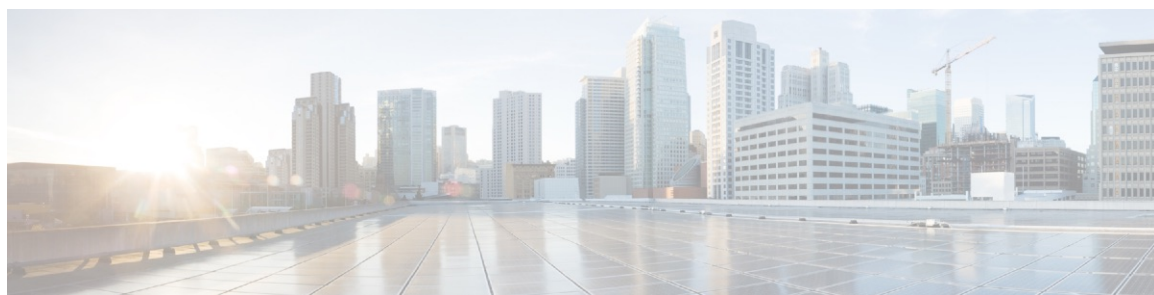
All printed copies and duplicate soft copies of this document are considered uncontrolled. See the current online version for the latest version.

Cisco has more than 200 offices worldwide. Addresses and phone numbers are listed on the Cisco website at [www.cisco.com/go/offices](http://www.cisco.com/go/offices).

The documentation set for this product strives to use bias-free language. For purposes of this documentation set, bias-free is defined as language that does not imply discrimination based on age, disability, gender, racial identity, ethnic identity, sexual orientation, socioeconomic status, and intersectionality. Exceptions may be present in the documentation due to language that is hardcoded in the user interfaces of the product software, language used based on standards documentation, or language that is used by a referenced third-party product.

Cisco and the Cisco logo are trademarks or registered trademarks of Cisco and/or its affiliates in the U.S. and other countries. To view a list of Cisco trademarks, go to this URL: <https://www.cisco.com/c/en/us/about/legal/trademarks.html>. Third-party trademarks mentioned are the property of their respective owners. The use of the word partner does not imply a partnership relationship between Cisco and any other company. (1721R)

© 2019-2022 Cisco Systems, Inc. All rights reserved.



## CONTENTS

---

### CHAPTER 1

#### Overview 1

- Features 1
- Package Contents 5
- QR Code Sticker 6
- Serial Number Location 7
- Front Panel 8
- Rear Panel 8
- Rear Panel LEDs 9
- Hardware Specifications 11
- Product ID Numbers 11
- Power Cord Specifications 12

---

### CHAPTER 2

#### Installation Preparation 19

- Installation Warnings 19
- Safety Recommendations 21
- Maintain Safety with Electricity 22
- Prevent ESD Damage 22
- Site Environment 23
- Site Considerations 23
- Power Supply Considerations 23
- Rack Configuration Considerations 24

---

### CHAPTER 3

#### Rack-Mount the Chassis 25

- Unpack and Inspect the Chassis 25
- Rack-Mount the Chassis 25

---

<b>CHAPTER 4</b>	<b>Connect to the Console Port</b>	<b>29</b>
	Connect to the Console Port with Microsoft Windows	29
	Connect to the Console Port with Mac OS X	31
	Connect to the Console Port with Linux	31

---

<b>CHAPTER 5</b>	<b>Installation, Maintenance, and Upgrade</b>	<b>33</b>
	Replace the SSD	33
	Install the FIPS Opacity Shield in a Two-Post Rack	34



# CHAPTER 1

## Overview

---

- [Features, on page 1](#)
- [Package Contents, on page 5](#)
- [QR Code Sticker, on page 6](#)
- [Serial Number Location, on page 7](#)
- [Front Panel, on page 8](#)
- [Rear Panel, on page 8](#)
- [Rear Panel LEDs, on page 9](#)
- [Hardware Specifications, on page 11](#)
- [Product ID Numbers, on page 11](#)
- [Power Cord Specifications, on page 12](#)

## Features

The Cisco Firepower 1100 security appliances are a standalone modular security services platform. They are capable of running multiple security services simultaneously and so are targeted at the data center as a multiservice platform. See [Product ID Numbers, on page 11](#) for a list of the product IDs (PIDs) associated with the Firepower 1100.

The Firepower 1000 supports Cisco Firepower Threat Defense and Cisco ASA software. See the [Cisco Firepower Compatibility Guide](#) and the [Cisco ASA Compatibility](#) guide, which provide Cisco software and hardware compatibility, including operating system and hosting environment requirements, for each supported version.

The following figure shows the Cisco Firepower 1100 chassis.

**Figure 1: Cisco Firepower 1100**



The following table lists the features for the Firepower 1100

Table 1: Firepower 1120, 1140, and 1150 Features

Feature	1120	1140	1150
Security standards certifications	<ul style="list-style-type: none"> <li>• Certified for the 1120, 1140, and 1150 on ASA 9.16.x:               <ul style="list-style-type: none"> <li>• Common Criteria Certification for the Network Device Collaborative Protection Profile (NDcPPv2.2E)</li> <li>• Firewall Collaborative Protection Profile Module (FW_MOD_v1.4e)</li> <li>• Virtual Private Network Gateway Protection Profile Module (VPNGW_MOD_v1.1)</li> </ul> </li> <li>• Certified for the 1120 and 1140 on FTD 6.4.x and FX-OS 2.6.x:               <ul style="list-style-type: none"> <li>• Common Criteria Certification for the Network Device Collaborative Protection Profile (NDcPPv2.2E)</li> <li>• IPS Extended Package (IPSEP v2.11)</li> <li>• Firewall Collaborative Protection Profile Module (MOD_FW_v1.4e)</li> <li>• Virtual Private Network Gateway Protection Profile Module (MOD_VPNGW_v1.1)</li> </ul> </li> <li>• Federal Information Processing Standards (FIPS) 140-2 certified for the 1120 and 1140 on FTD 6.4.x and FX-OS 2.6.x.</li> <li>• Department of Defense Information Network Approved Product List (DoDIN APL) certified on the 1120 and 1140.</li> <li>• US Government Compliance for IPv6 (USGv6) on FTD 7.0.x— Certification Approval under the R1 Profile for the Product Classification “NPP” certified on the 1120, 1140, and 1150.</li> </ul> <p>See the "Security Certifications Compliance" topic in the "Appliance Platform Settings" chapter in the <a href="#">Firepower Management Center Configuration Guide, Version 6.7</a> for the instructions on how to enable security certifications compliance.</p>		
Form factor	1 RU		
Mounting	Rack mount 4-post Electronic Industries Association (EIA)-310-D rack		
Airflow	I/O side to non-I/O side Rear panel to front panel (cold aisle to hot aisle)		
Processor	One 12-core Intel CPU	One 16-core Intel CPU	
Memory	16-GB DDR4 DRAM		32-GB DDR4 DRAM
Management port	One Gigabit Ethernet RJ-45 10/100/1000 BaseT Restricted to network management access only		

Feature	1120	1140	1150
Console ports	One RJ-45 or one USB Mini B Provides management access through an external system		
USB port	One USB 3.0 Type A Allows attachment of an external device such as mass storage		
Network ports	Eight Gigabit Ethernet RJ-45 10/100/1000 BaseT Each RJ-45 (8P8C) copper port supports auto Medium Dependent Interface Crossover (MDI/X) as well as auto-negotiation for interface speed, duplex, and other negotiated parameters, and are MDI/X-compliant. Port numbering is left to right, top to bottom; ports are named Gigabit Ethernet 1/1 through 1/8. Each port includes a pair of LEDs, one each for connection status and link status.		
Small form-factor pluggable (SFP) ports	Four fixed 1-Gb SFP ports		Four fixed 1-Gb SFP ports <b>Note</b> Two of the SFP ports (ports 9 and 11) support 10 Gbps.
Supported SFPs	<ul style="list-style-type: none"> <li>• GLC-SX-MMD</li> <li>• GLC-LH-SMD</li> <li>• GLC-EX-SMD</li> <li>• GLC-ZX-SMD</li> <li>• GLC-T/TE</li> </ul> <p>The SFPs are hot-swappable.</p>		<ul style="list-style-type: none"> <li>• SFP-10G-SR</li> <li>• SFP-10G-LR</li> <li>• SFP-10G-ER</li> <li>• SFP-10G-SR-S</li> <li>• SFP-10G-LR-S</li> <li>• SFP-10G-ZR-S</li> <li>• SFP-10G-ER-S</li> <li>• SFP-H10GB-CU 1M/1-5M/2M/ 2-5M/3M/5M</li> <li>• SFP-H10GB-ACU 7M/10M</li> <li>• SFP-10G-AOC 1M/2M/3M/ 5M/7M/10M</li> </ul>

Feature	1120	1140	1150
Power switch	Yes On rear panel; standard rocker-type power on/off switch <b>Note</b> The power switch controls system power and operates as a soft notification switch that supports the graceful shutdown of the system. Graceful shutdown reduces the risk of system software and data corruption.		
Reset button	A small recessed button that if pressed for longer than three seconds resets the chassis to its default state following the next reboot. Configuration variables are reset to factory default. However, the flash is not erased, and no files are removed.		
AC power supply	One fixed AC power supply The power supply is internal; there is no user access. The power supply is not field-replaceable; you must return the chassis to Cisco for power supply replacement.		
Redundant power	No		
Fan	One fixed fan The fan is internal; there is no user access. The fan is not field-replaceable; you must return the chassis to Cisco for fan replacement.		
Storage	One SSD slot 200-GB 2.5-in. SATA SSD drive The drive is field-replaceable. See <a href="#">Replace the SSD, on page 33</a> for more information.		

### Console Ports

The Firepower 1100 has two external console ports, a standard RJ-45 port and a USB Mini B serial port. Only one console port can be active at a time. When a cable is plugged into the USB console port, the RJ-45 port becomes inactive. Conversely, when the USB cable is removed from the USB port, the RJ-45 port becomes active. The console ports do not have any hardware flow control. You can use the CLI to configure the chassis through either serial console port by using a terminal server or a terminal emulation program on a computer.

- RJ-45 (8P8C) port—Supports RS-232 signaling to an internal UART controller. The RJ-45 console port does not support a remote dial-in modem. You can use a standard management cable (Cisco part number 72-3383-01) to convert the RJ45-to-DB9 connection if necessary.
- USB Mini B port—Lets you connect to a USB port on an external computer. For Linux and Macintosh systems, no special driver is required. For Windows systems, you must download and install a USB driver (available on software.cisco.com). You can plug and unplug the USB cable from the console port without affecting Windows HyperTerminal operations. We recommend shielded USB cables with properly terminated shields. Baud rates for the USB console port are 1200, 2400, 4800, 9600, 19200, 38400, 57600, and 115200 bps.





---

**Note** For Windows operating systems, you must install a Cisco Windows USB Console Driver on any PC connected to the console port before using the USB console port. See [Connect to the Console Port with Microsoft Windows, on page 29](#) for information on installing the driver.

---

### External Flash Storage

The chassis contains a standard USB Type A port that you can use to attach an external device. The USB port can provide output power of 5 volts, up to a maximum of 1 A (5 USB power units).

- External USB drive (optional)—You can use the external USB Type A port to attach a data-storage device. The external USB drive identifier is *disk1*. When the chassis is powered on, a connected USB drive is mounted as *disk1* and is available for you to use. Additionally, the file-system commands that are available to *disk0* are also available to *disk1*, including **copy**, **format**, **delete**, **mkdir**, **pwd**, **cd**, and so on.
- FAT-32 File System—The Firepower 1100 only supports FAT-32-formatted file systems for the external USB drive. If you insert an external USB drive that is not in FAT-32 format, the system mounting process fails, and you receive an error message. You can enter the command **format disk1**: to format the partition to FAT-32 and mount the partition to *disk1* again; however, data might be lost.

## Package Contents

The following figure shows the package contents for the Firepower 1100. Note that the contents are subject to change, and your exact contents might contain additional or fewer items.

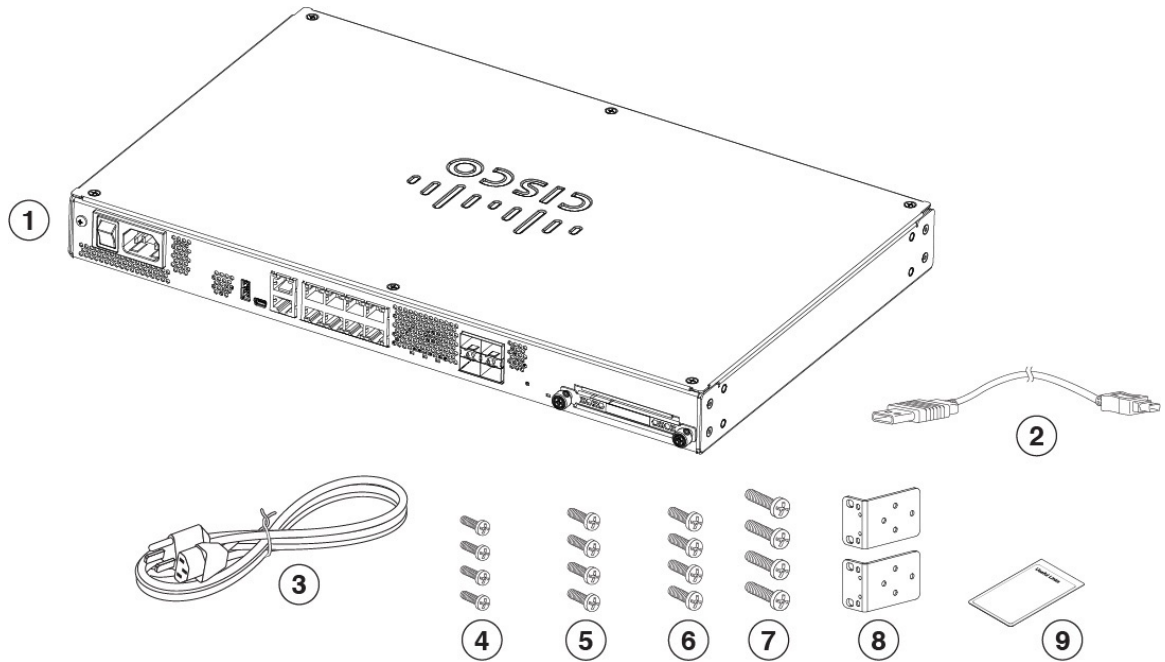


---

**Note** There are three sets of four screws that you can use to secure the chassis to your rack. Chose the screws that fit your rack.

---

Figure 2: Firepower 1100 Package Contents



<p><b>1</b> Chassis</p>	<p><b>2</b> USB console cable Type A to Mini Type B (part number 53-1977-01)</p>
<p><b>3</b> Power cord</p>	<p><b>4</b> Four 10-32 x 0.75-inch Phillips screws (part number 48-0441-01) for securing the chassis to your rack</p>
<p><b>5</b> Four 12-24 x 0.75-inch Phillips screws (part number 48-0440-01) for securing the chassis to your rack</p>	<p><b>6</b> Four M6 x 1 x1 9-mm Phillips screws (part number 48-101022-01) for securing the chassis to your rack</p>
<p><b>7</b> Four M4 x 8-mm Phillips screws (part number 48-0451-01) for securing the rack-mounting bracket to the chassis</p>	<p><b>8</b> Two rack-mount brackets (part number 700-117078-01)</p>
<p><b>9</b> <i>Cisco Firepower 1100</i>  This document has a URL pointing to the hardware installation guide, a URL pointing to the regulatory and safety guide, and a QR code and URL pointing to the Getting Started Guide.</p>	<p>—</p>

## QR Code Sticker

The QR code sticker on the rear panel of the chassis points to the [Easy Deployment Guide for Cisco Secure Firewall 1000, 2100, and 3100 Series](#) that explains low touch provisioning (LTP). LTP allows anyone to

connect a new Firepower 1100 to a network so that the IT department can on board the device to CDO and configure it remotely. CDO supports Firepower Threat Defense (FTD) version 6.7 and later.

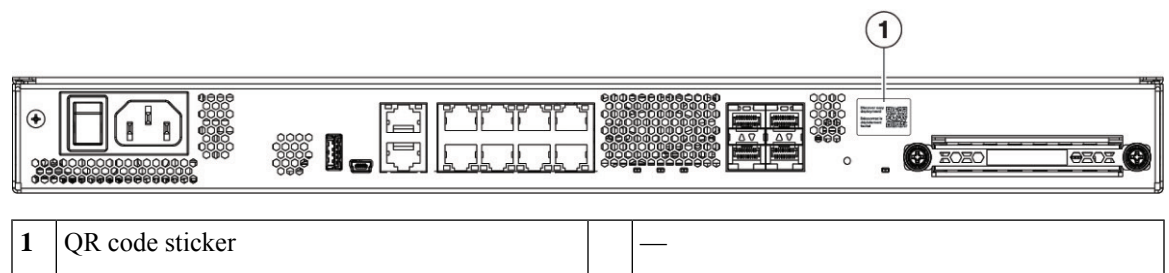
The following figure shows the QR code sticker.

*Figure 3: QR Code Sticker*



The following figure shows the placement of the QR code sticker on the rear panel of the chassis.

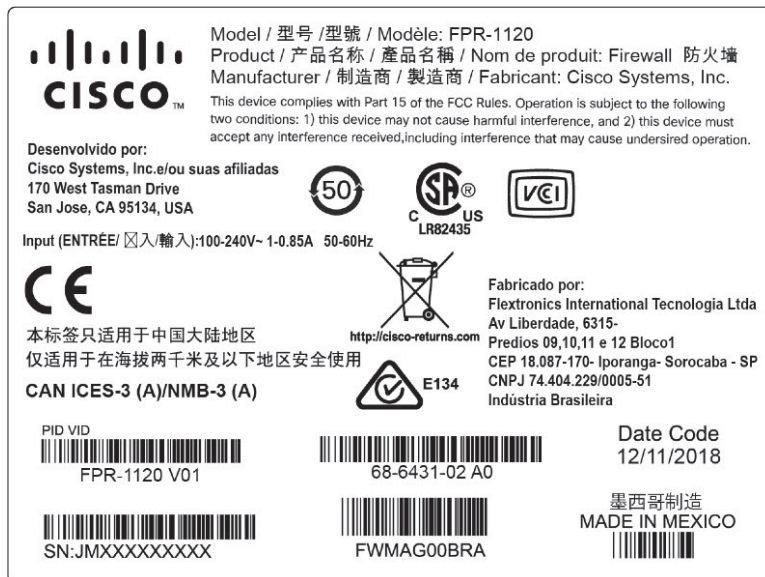
*Figure 4: QR Code Sticker on the Chassis*



## Serial Number Location

You can view the serial number and additional model information on the compliance label located on the bottom of the chassis. The following figure shows a sample compliance label.

Figure 5: Compliance Label on the Chassis



## Front Panel

The following figure shows the front panel of the Firepower 1100. Note that there are no connectors or LEDs on the front panel.

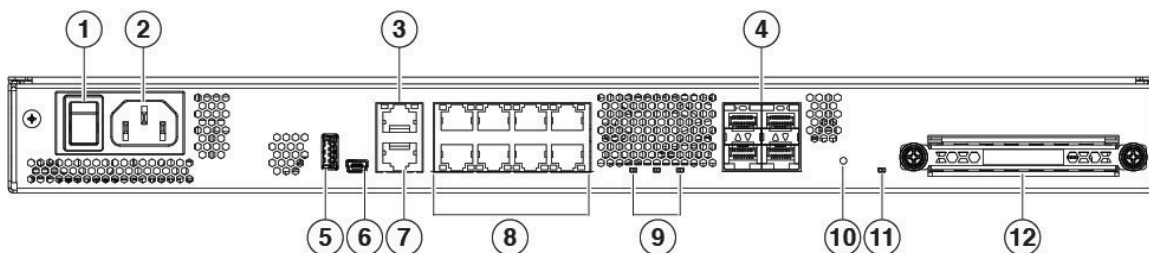
Figure 6: Firepower 1100 Front Panel



## Rear Panel

The following figure shows the rear panel of the Firepower 1100. See [Rear Panel LEDs, on page 9](#) for a description of the LEDs. See [Features, on page 1](#) for a description of each feature.

Figure 7: Firepower 1100 Rear Panel

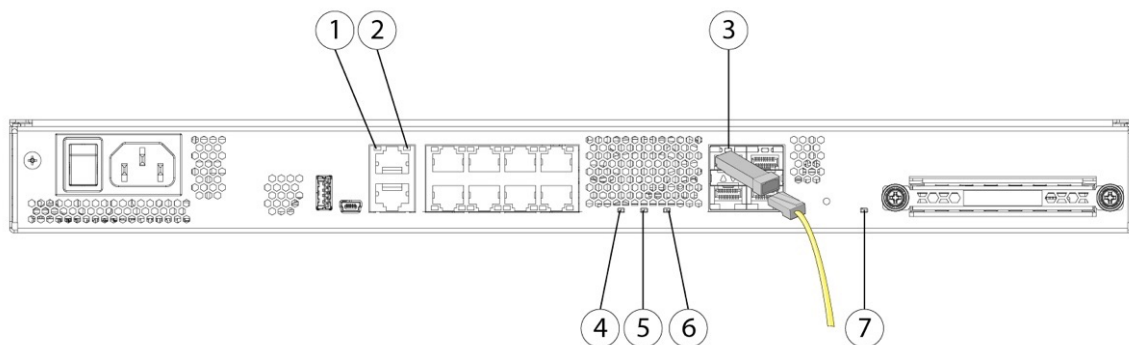


<p><b>1</b> Power switch</p> <p><b>Note</b> The power switch provides a way to gracefully shut down the system and place it in standby. The power supply and fan remain active and the fan may continue to spin at slow speed. To achieve total power shut down, unplug the power supply from the chassis.</p>	<p><b>2</b> Power cord socket</p>
<p><b>3</b> Management port</p>	<p><b>4</b> SFP ports (numbered 9 through 12)</p>
<p><b>5</b> USB Type A port</p>	<p><b>6</b> USB Mini B console port</p>
<p><b>7</b> RJ-45 (8P8C) console port</p>	<p><b>8</b> Network data ports</p>
<p><b>9</b> Status LEDs</p>	<p><b>10</b> Reset button</p>
<p><b>11</b> SSD LED</p>	<p><b>12</b> SSD bay</p>

## Rear Panel LEDs

The following figure shows the LEDs on the rear panel of the Firepower 1100 and describes their states.

**Figure 8: Firepower 1100 Rear Panel LEDs**



<p><b>1 Network</b></p> <p>Status of the network ports:</p> <p>Link status (L):</p> <ul style="list-style-type: none"> <li>• Off—No link, or port is not in use.</li> <li>• Green—Link established.</li> <li>• Green, flashing—Link activity.</li> </ul>	<p><b>2 Network</b></p> <p>Status of the network ports:</p> <p>Connection-speed status (S):</p> <ul style="list-style-type: none"> <li>• Green, flashing—One flash every three seconds = 10 Mbps.</li> <li>• Green, flashing—Two rapid flashes = 100 Mbps.</li> <li>• Green, flashing—Three rapid flashes = 1000 Mbps.</li> </ul>
--	---

<p><b>3 SFP</b></p> <p>Status of the SFP transceiver:</p> <p>Link status (L):</p> <ul style="list-style-type: none"> <li>• Off—No SFP.</li> <li>• Amber—SFP present, but no link.</li> <li>• Green, flashing—Link established and transmitting.</li> </ul>	<p><b>4 Power</b></p> <p>Power supply status:</p> <ul style="list-style-type: none"> <li>• Off —Power supply off.</li> <li>• Green—Power supply on.</li> </ul>
<p><b>5 Status</b></p> <p>System operating status:</p> <ul style="list-style-type: none"> <li>• Off—System has not booted up yet.</li> <li>• Green, flashing quickly—System is booting up.</li> <li>• Green—Normal system function.</li> <li>• Amber—Critical alarm indicating one or more of the following: <ul style="list-style-type: none"> <li>• Major failure of a hardware or software component.</li> <li>• Over-temperature condition.</li> <li>• Power voltage outside the tolerance range.</li> </ul> </li> <li>• Green, flashing slowly (twice in 5 seconds)—Cloud connected.</li> </ul> <p><b>Note</b> Cisco Defense Orchestrator (CDO) is valid for FTD 6.7 and later.</p> <ul style="list-style-type: none"> <li>• Green and amber, flashing—Cloud connection failure.</li> <li>• Green—Cloud disconnected.</li> </ul> <p><b>Note</b> The CDO LED pattern applies to low touch provisioning (LTP). See the <a href="#">Firepower Easy Deployment Guide for Cisco Firepower 1000 or 2100 Firewalls</a> for more information.</p>	<p><b>6 Active</b></p> <p>Status of the failover pair:</p> <ul style="list-style-type: none"> <li>• Off— Failover is not operational.</li> <li>• Green—Failover pair operating normally. The LED is green always unless the chassis in a high availability pair.</li> <li>• Amber—When the chassis is in a high availability pair, the LED is amber for the standby unit.</li> </ul>

<b>7</b>	<p><b>SSD</b></p> <p>Status of the SSD:</p> <ul style="list-style-type: none"> <li>• Off— No SSD present or no activity on the SSD.</li> <li>• Green—Activity on the SSD.</li> </ul> <p><b>Note</b> See <a href="#">Replace the SSD, on page 33</a> for the procedure for replacing a failed SSD.</p>	—
----------	---	---

## Hardware Specifications

The following table contains hardware specifications for the Firepower 1100.

**Table 2: Hardware Specifications**

Specification	1120	1140	1150
Dimensions (H x W x D)	1.72 x 10.58 x 17.2 inches (4.37 x 26.87 x 43.69 cm)		
Weight	8 lb (3.63 kg)		
Temperature	Operating: 32 to 104°F (0 to 40°C) Derate the maximum operating temperature 1.5°C per 1000 ft above sea level. Nonoperating: -13 to 158°F (-25 to 70°C) maximum altitude is 40,000 ft		
Humidity	Operating: 90% Nonoperating: 10 to 90%		
Altitude	Operating: 0 to 3,000 (0 to 9843 m) Nonoperating: 0 to 15,000 ft (0 to 4570 m)		
Acoustic noise	56.8 dBa (sound pressure) at maximum fan speed at 40C  31.7 dBa at room temperature	56.8 dBa (sound pressure) at maximum fan speed at 40C  34.2 dBa at room temperature	

## Product ID Numbers

The following table lists the field-replaceable PIDs associated with the Firepower 1100. The spare components are ones that you can order and replace yourself. If any internal components fail, you must get a return material authorization (RMA) for the entire chassis. See the [Cisco Returns Portal](#) for more information.



**Note** See the **show inventory** command in the [Cisco Firepower Threat Defense Command Reference](#) or the [Cisco ASA Series Command Reference](#) to display a list of the PIDs for your Firepower 1100.

**Table 3: Firepower 1100 Series PIDs**

PID	Description
FPR1120-NGFW-K9	Cisco Firepower 1120 NGFW appliance
FPR1140-NGFW-K9	Cisco Firepower 1140 NGFW appliance
FPR1150-NGFW-K9	Cisco Firepower 1150 NGFW appliance
FPR1K-RM-SSD200	Cisco Firepower 1100 200-GB drive
FPR1K-RM-SSD200=	Cisco Firepower 1100 200-GB drive (spare)
FPR1K-CBL-MGMT	Cisco Firepower 1100 cable-management brackets
FPR1K-CBL-MGMT=	Cisco Firepower 1100 cable-management brackets (spare)
FPR1K-RM-ACY-KIT	Cisco Firepower 1100 accessory kit
FPR1K-RM-BRKT=	Cisco Firepower 1100 rack-mount brackets (spare)
FPR1K-RM-FIPS-KIT	Cisco Firepower 1100 FIPS kit

## Power Cord Specifications

Each power supply has a separate power cord. Standard power cords or jumper power cords are available for connection to the security appliance. The jumper power cords for use in racks are available as an optional alternative to the standard power cords.

If you do not order the optional power cord with the system, you are responsible for selecting the appropriate power cord for the product. Using an incompatible power cord with this product may result in electrical safety hazard. Orders delivered to Argentina, Brazil, and Japan must have the appropriate power cord ordered with the system.

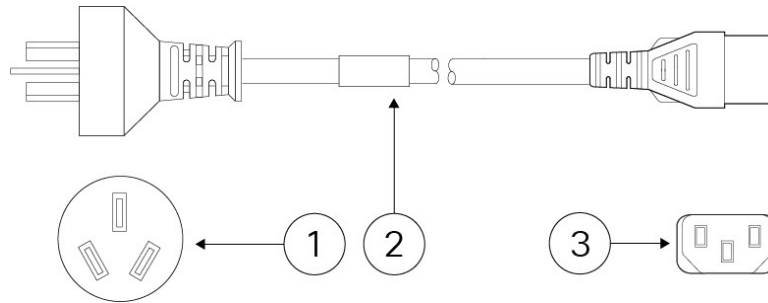


**Note** Only the approved power cords or jumper power cords provided with the chassis are supported.

The following power cords are supported.

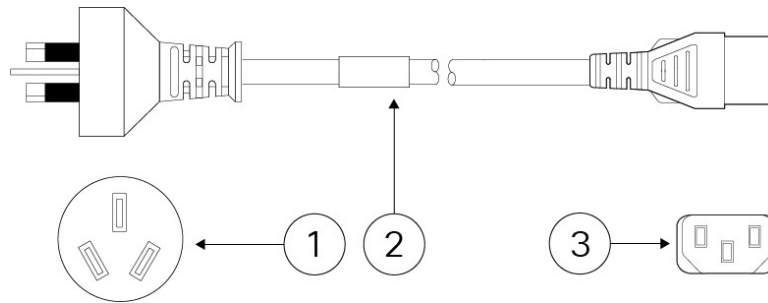


**Figure 9: Argentina (CAB-ACR)**



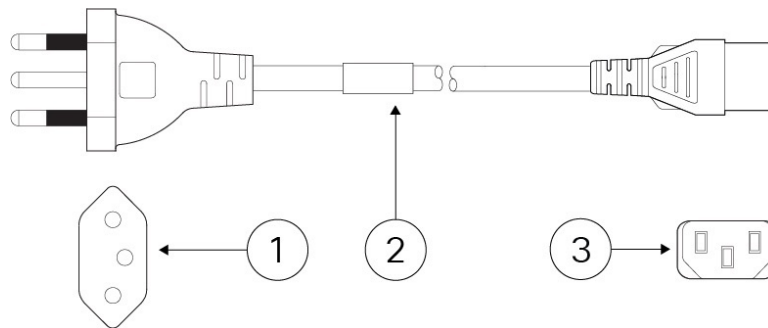
<b>1</b>	Plug: VA2073	<b>2</b>	Cord set rating: 10 A, 250 V
<b>3</b>	Connector: V1625		—

**Figure 10: Australia/New Zealand (CAB-ACA)**



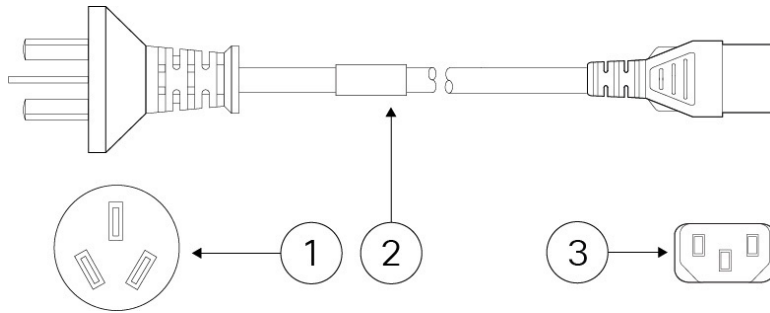
<b>1</b>	Plug: AU10LS3	<b>2</b>	Cord set rating: 10 A, 250 V
<b>3</b>	Connector: V1625		—

**Figure 11: Brazil (CAB-C13-ACB)**



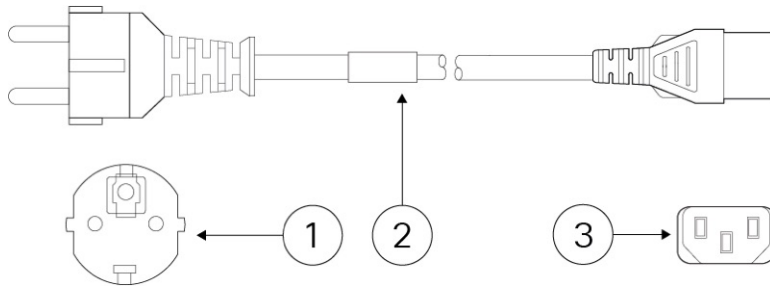
<b>1</b>	Plug: NBR 14136	<b>2</b>	Cord set rating: 10 A, 250 V
<b>3</b>	Connector: EL 701B (EN 60320/C13)		—

**Figure 12: China (CAB-ACC)**



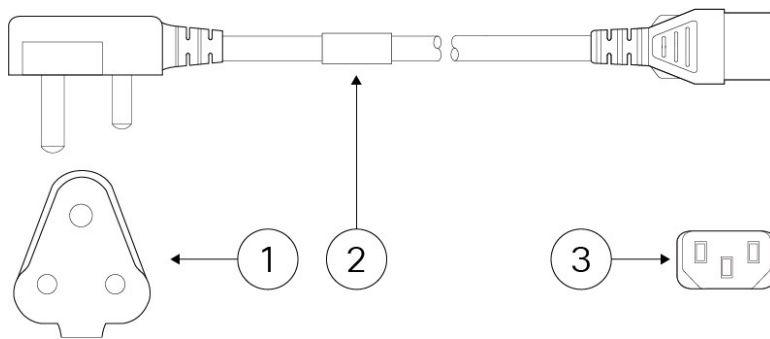
<b>1</b>	Plug: V3203C	<b>2</b>	Cord set rating: 10 A, 250 V
<b>3</b>	Connector: V1625		—

**Figure 13: Europe (CAB-ACE)**



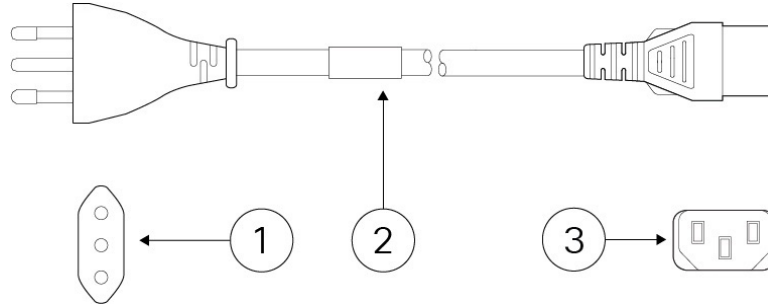
<b>1</b>	Plug: M2511	<b>2</b>	Cord set rating: 16 A, 250 V
<b>3</b>	Connector: V1625		—

**Figure 14: India (CAB-IND-10A)**



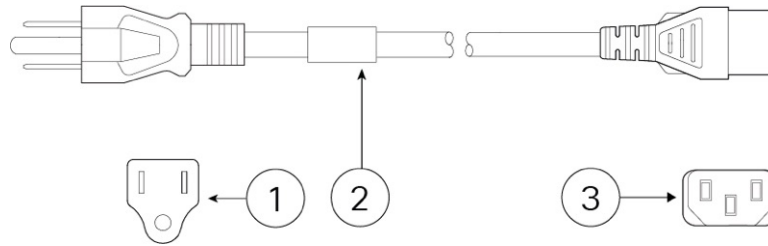
<b>1</b>	Plug: IA16A3-C	<b>2</b>	Cord set rating: 16 A, 250 V
<b>3</b>	Connector: V1625BS-E		—

**Figure 15: Italy (CAB-ACI)**



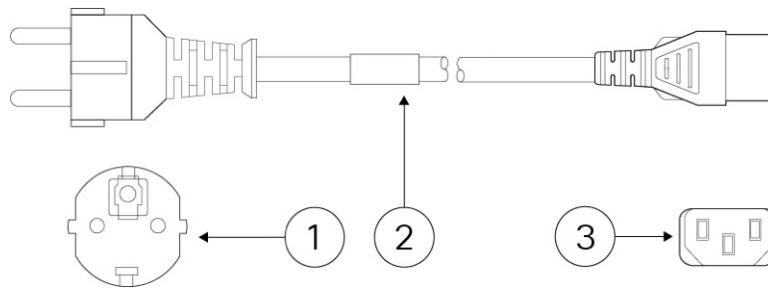
<b>1</b>	Plug: IT10S3	<b>2</b>	Cord set rating: 10 A, 250 V
<b>3</b>	Connector: V1625		—

**Figure 16: Japan (CAB-JPN-3PIN)**



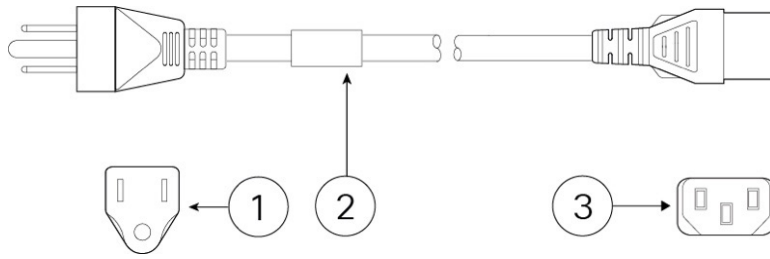
<b>1</b>	Plug: M744	<b>2</b>	Cord set rating: 12 A, 125 V
<b>3</b>	Connector: V1625		—

**Figure 17: Korea (CAB-AC-C13-KOR)**



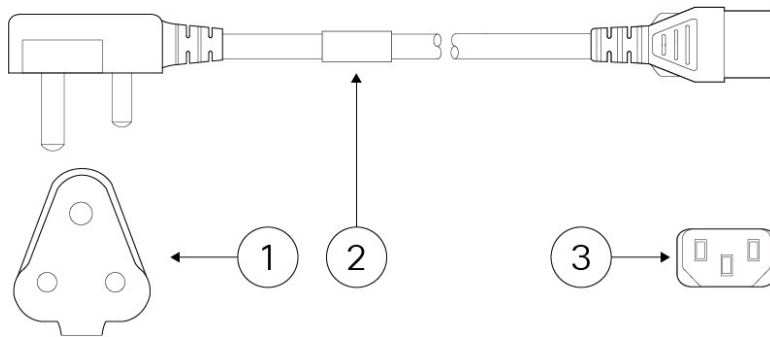
<b>1</b>	Plug: M2511	<b>2</b>	Cord set rating: 10 A, 250 V
<b>3</b>	Connector: V1625		—

**Figure 18: North America (CAB-AC)**



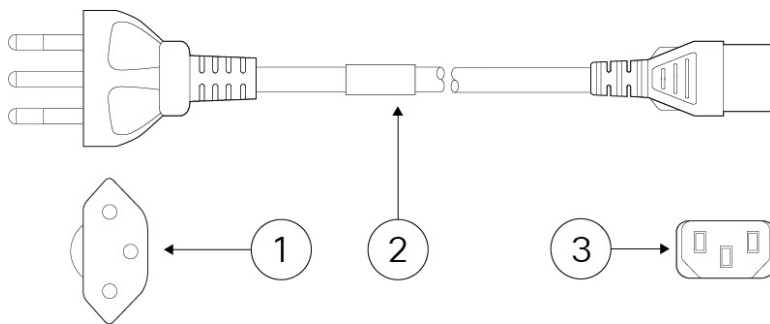
<b>1</b>	Plug: PS204	<b>2</b>	Cord set rating: 10 A, 250 V
<b>3</b>	Connector: V1625		

**Figure 19: South Africa (AIR-PWR-CORD-SA)**



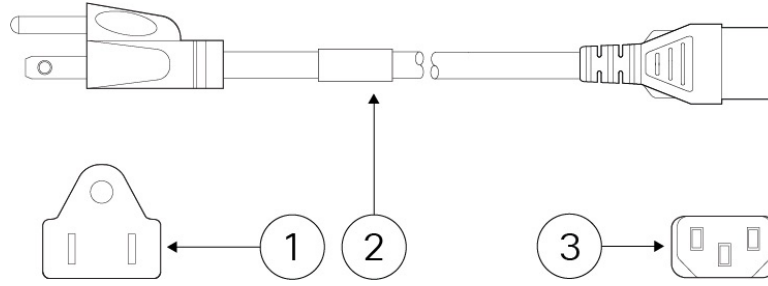
<b>1</b>	Plug: SA16A	<b>2</b>	Cord set rating: 10 A, 250 V
<b>3</b>	Connector: V1625		—

**Figure 20: Switzerland (CAB-ACS)**



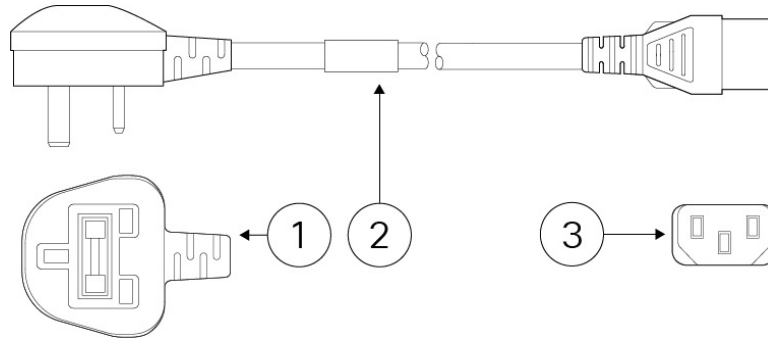
<b>1</b>	Plug: SW10ZS3	<b>2</b>	Cord set rating: 10 A, 250 V
<b>3</b>	Connector: V1625		—

**Figure 21: Taiwan (CAB-ACTW)**



<b>1</b>	Plug: EL 302 (CNS10917)	<b>2</b>	Cord set rating: 10 A, 125 V
<b>3</b>	Connector: EL 701 (EN 60320/C13)		—

**Figure 22: United Kingdom (CAB-ACU)**



<b>1</b>	Plug: 3P BS 1363	<b>2</b>	Cord set rating: 10 A, 250 V
<b>3</b>	Connector: IEC 60320/C13		—





## CHAPTER 2

# Installation Preparation

---

- [Installation Warnings](#), on page 19
- [Safety Recommendations](#), on page 21
- [Maintain Safety with Electricity](#), on page 22
- [Prevent ESD Damage](#), on page 22
- [Site Environment](#), on page 23
- [Site Considerations](#), on page 23
- [Power Supply Considerations](#), on page 23
- [Rack Configuration Considerations](#), on page 24

## Installation Warnings

Read the [Regulatory and Compliance Information](#) document before installing the chassis.

Take note of the following warnings:



---

**Warning** **Statement 1071**—Warning Definition

**IMPORTANT SAFETY INSTRUCTIONS**

Before you work on any equipment, be aware of the hazards involved with electrical circuitry and be familiar with standard practices for preventing accidents. Read the installation instructions before using, installing, or connecting the system to the power source. Use the statement number provided at the end of each warning statement to locate its translation in the translated safety warnings for this device.

SAVE THESE INSTRUCTIONS



---

**Warning** **Statement 1004**—Installation Instructions

Read the installation instructions before using, installing, or connecting the system to the power source.

---



---

**Warning Statement 1005**—Circuit Breaker

This product relies on the building's installation for short-circuit (overcurrent) protection. To reduce risk of electric shock or fire, ensure that the protective device is rated not greater than: 20 A, 120 V, and 16 A, 250 V

---



---

**Warning Statement 1015**—Battery Handling

To reduce risk of fire, explosion or leakage of flammable liquid or gas:

- Replace the battery only with the same or equivalent type recommended by the manufacturer.
  - Do not dismantle, crush, puncture, use a sharp tool to remove, short external contacts, or dispose of the battery in fire.
  - Do not use if battery is warped or swollen.
  - Do not store or use battery in a temperature > 60° C.
- 



---

**Warning Statement 1017**—Restricted Area

This unit is intended for installation in restricted access areas. Only skilled, instructed, or qualified personnel can access a restricted access area.

---



---

**Warning Statement 1021**—SELV Circuit

To avoid electric shock, do not connect SELV circuits to telephone-network voltage (TNV) circuits. LAN ports contain SELV circuits, and WAN ports contain TNV circuits. Some LAN and WAN ports both use RJ-45 connectors. Use caution when connecting cables.

---



---

**Warning Statement 1024**—Ground Conductor

This equipment must be grounded. To reduce the risk of electric shock, never defeat the ground conductor or operate the equipment in the absence of a suitably installed ground conductor. Contact the appropriate electrical inspection authority or an electrician if you are uncertain that suitable grounding is available.

---



---

**Warning Statement 1029**—Blank Faceplates and Cover Panels

Blank faceplates and cover panels serve three important functions: they reduce the risk of electric shock and fire, they contain electromagnetic interference (EMI) that might disrupt other equipment, and they direct the flow of cooling air through the chassis. Do not operate the system unless all cards, faceplates, front covers, and rear covers are in place.

---



**Warning Statement 1030—Equipment Installation**

Only trained and qualified personnel should be allowed to install, replace, or service this equipment.

**Warning Statement 1040—Product Disposal**

Ultimate disposal of this product should be handled according to all national laws and regulations.

**Warning Statement 1045—Short-Circuit Protection**

This product requires short-circuit (overcurrent) protection to be provided as part of the building installation. Install only in accordance with national and local wiring regulations.

**Warning Statement 1051—Laser Radiation**

Invisible laser radiation may be emitted from disconnected fibers or connectors. Do not stare into beams or view directly with optical instruments.

**Warning Statement 1055—Class 1/1M Laser**

Invisible laser radiation is present. Do not expose to users of telescopic optics. This applies to Class 1/1M laser products.

**Warning Statement 1074—Comply with Local and National Electrical Codes**

To reduce risk of electric shock or fire, installation of the equipment must comply with local and national electrical codes.

## Safety Recommendations

Observe these safety guidelines:

- Keep the area clear and dust free before, during, and after installation.
- Keep tools away from walkways, where you and others might trip over them.

- Do not wear loose clothing or jewelry, such as earrings, bracelets, or chains that could get caught in the chassis.
- Wear safety glasses if you are working under any conditions that might be hazardous to your eyes.
- Do not perform any action that creates a potential hazard to people or makes the equipment unsafe.
- Never attempt to lift an object that is too heavy for one person.

## Maintain Safety with Electricity



---

**Warning** Before working on a chassis, be sure the power cord is unplugged.

---

Read the [Regulatory and Compliance Information](#) document before installing the chassis.

Follow these guidelines when working on equipment powered by electricity:

- Before beginning procedures that require access to the interior of the chassis, locate the emergency power-off switch for the room in which you are working. Then, if an electrical accident occurs, you can act quickly to turn off the power.
- Do not work alone if potentially hazardous conditions exist anywhere in your work space.
- Never assume that power is disconnected; always check.
- Look carefully for possible hazards in your work area, such as moist floors, ungrounded power extension cables, frayed power cords, and missing safety grounds.
- Use the chassis within its marked electrical ratings and product usage instructions.
- The chassis is equipped with an AC-input power supply, which is shipped with a three-wire electrical cord with a grounding-type plug that fits into a grounding-type power outlet only. Do not circumvent this safety feature. Equipment grounding should comply with local and national electrical codes.

## Prevent ESD Damage

ESD occurs when electronic components are improperly handled, and it can damage equipment and impair electrical circuitry, which can result in intermittent or complete failure of your equipment.

Always follow ESD-prevention procedures when removing and replacing components. Ensure that the chassis is electrically connected to an earth ground. Wear an ESD-preventive wrist strap, ensuring that it makes good skin contact. Connect the grounding clip to an unpainted surface of the chassis frame to safely ground ESD voltages. To properly guard against ESD damage and shocks, the wrist strap and cord must operate effectively. If no wrist strap is available, ground yourself by touching the metal part of the chassis.

For safety, periodically check the resistance value of the antistatic strap, which should be between one and 10 megohms.

## Site Environment

See [Hardware Specifications, on page 11](#) for information about physical specifications.

To avoid equipment failures and reduce the possibility of environmentally caused shutdowns, plan the site layout and equipment locations carefully. If you are currently experiencing shutdowns or unusually high error rates with your existing equipment, these considerations may help you isolate the cause of failures and prevent future problems.

## Site Considerations

Considering the following helps you plan an acceptable operating environment for the chassis, and avoid environmentally-caused equipment failures.

- Electrical equipment generates heat. Ambient air temperature might not be adequate to cool equipment to acceptable operating temperatures without adequate circulation. Make sure that the room in which you operate your system has adequate air circulation.
- Ensure that the chassis cover is secure. The chassis is designed to allow cooling air to flow effectively within it. An open chassis allows air leaks, which may interrupt and redirect the flow of cooling air from the internal components.
- Always follow ESD-prevention procedures to avoid damage to equipment. Damage from static discharge can cause immediate or intermittent equipment failure.

## Power Supply Considerations

See [Hardware Specifications, on page 11](#) for more detailed information about the power supply in the chassis.

When installing the chassis, consider the following:

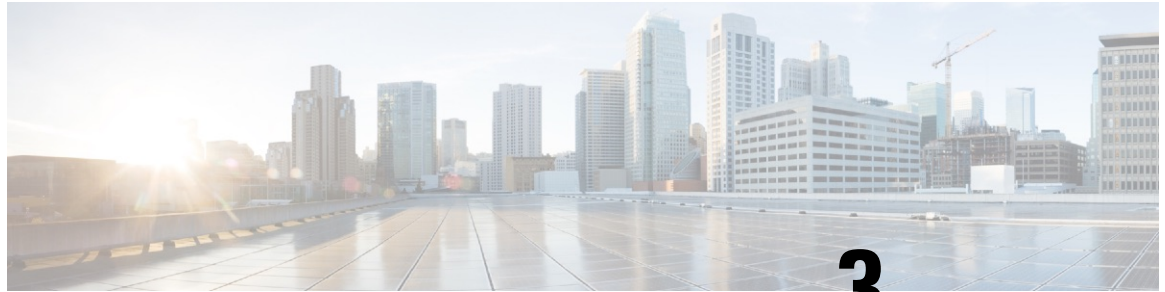
- Check the power at the site before installing the chassis to ensure that it is free of spikes and noise. Install a power conditioner, if necessary, to ensure proper voltages and power levels in the appliance-input voltage.
- Install proper grounding for the site to avoid damage from lightning and power surges.
- The chassis does not have a user-selectable operating range. Refer to the label on the chassis for the correct appliance input-power requirement.
- Several styles of AC-input power supply cords are available for the chassis; make sure that you have the correct style for your site.
- If you are using dual redundant (1+1) power supplies, we recommend that you use independent electrical circuits for each power supply.
- Install an uninterruptible power source for your site, if possible.

# Rack Configuration Considerations

See [Rack-Mount the Chassis, on page 25](#) for the procedure for rack-mounting the chassis.

Consider the following when planning a rack configuration:

- If you are mounting a chassis in an open rack, make sure that the rack frame does not block the intake or exhaust ports.
- If your rack includes closing front and rear doors, the doors must have 65 percent open perforated area evenly distributed from top to bottom to permit adequate airflow.
- Be sure enclosed racks have adequate ventilation. Make sure that the rack is not overly congested as each chassis generates heat. An enclosed rack should have louvered sides and a fan to provide cooling air.
- In an enclosed rack with a ventilation fan in the top, heat generated by equipment near the bottom of the rack can be drawn upward and into the intake ports of the equipment above it in the rack. Ensure that you provide adequate ventilation for equipment at the bottom of the rack.
- Baffles can help to isolate exhaust air from intake air, which also helps to draw cooling air through the chassis. The best placement of the baffles depends on the airflow patterns in the rack. Experiment with different arrangements to position the baffles effectively.



## CHAPTER 3

# Rack-Mount the Chassis

---

- [Unpack and Inspect the Chassis, on page 25](#)
- [Rack-Mount the Chassis, on page 25](#)

## Unpack and Inspect the Chassis



---

**Note** The chassis is thoroughly inspected before shipment. If any damage occurred during transportation or any items are missing, contact your customer service representative immediately. Keep the shipping container in case you need to send the chassis back due to damage.

---

See [Package Contents, on page 5](#) for a list of what shipped with the chassis.

- 
- Step 1** Remove the chassis from its cardboard container and save all packaging material.
- Step 2** Compare the shipment to the equipment list provided by your customer service representative. Verify that you have all items.
- Step 3** Check for damage and report any discrepancies or damage to your customer service representative. Have the following information ready:
- Invoice number of shipper (see the packing slip)
  - Model and serial number of the damaged unit
  - Description of damage
  - Effect of damage on the installation
- 

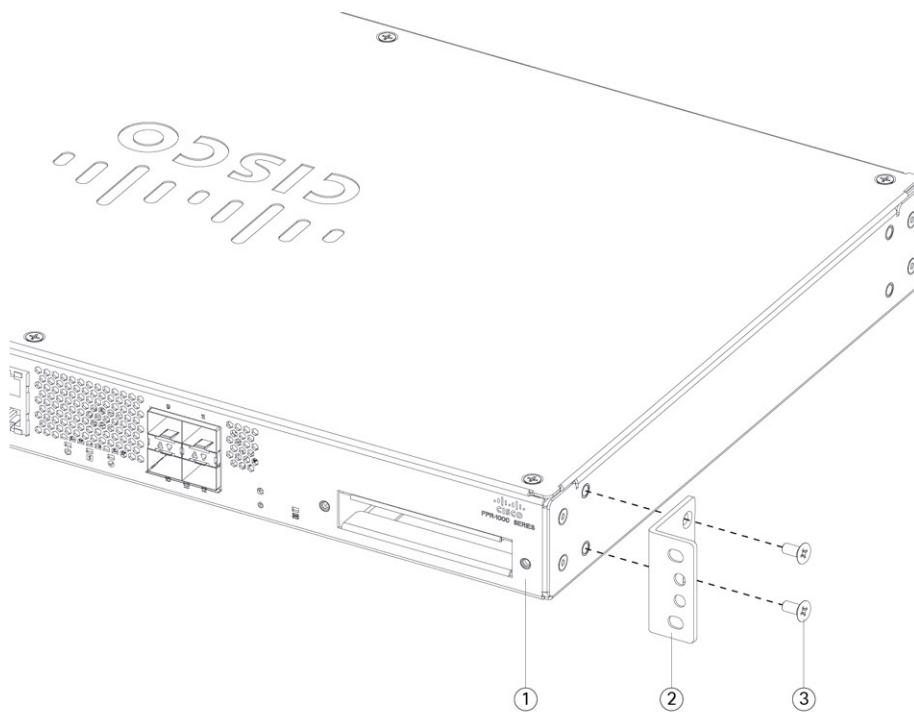
## Rack-Mount the Chassis

The chassis ships with rack-mount brackets and screws that you can install on the front or the rear of the chassis. We recommend you install the rack-mount brackets on the rear panel so that the chassis faces the hot aisle. See [Package Contents, on page 5](#) for the rack-mount items in the accessory kit.

The rack is a standard Electronic Industries Association (EIA) rack. It is a 4-post-EIA-310-D, which is the current revision as specified by EIA. The vertical hole spacing alternates at .50 inches (12.70 mm) to .625 inches (15.90 mm) to .625 inches (15.90 mm) and repeats. The start and stop space is in the middle of the .50-inch holes. The horizontal spacing is 18.312 inches (465.1 mm), and the rack opening is specified as a minimum of 17.75 inches (450 mm).

**Step 1** Attach both brackets (part number 700-117078-01) to the sides of the chassis using the four M4 x 8-mm Phillips screws (part number 848-0451-01) that shipped with your chassis. After the brackets are secured to the chassis, you can mount it in the rack.

**Figure 23: Attach Brackets to Chassis**



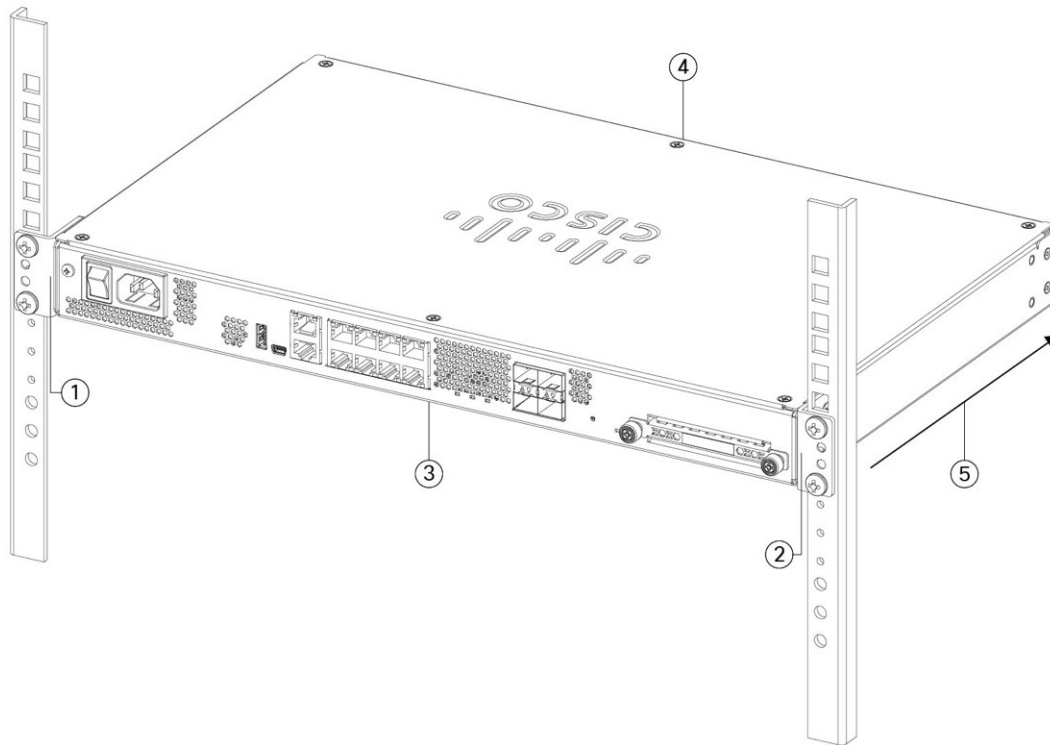
<b>1</b>	Chassis back panel	<b>2</b>	Rack-mount bracket
<b>3</b>	M4 x 8-mm Phillips screws (two per side)		—

**Step 2** Attach the chassis to the rack using the screws that shipped with the chassis.

**Note** There are three sets of four screws that you can use to secure the chassis to your rack. Chose the screws that fit your rack. See [Package Contents, on page 5](#) for the list of rack screws.

We recommend that you install the chassis with the I/O side (rear panel) facing the cold aisle. See the following illustration for an example of air flow from rear panel (cold aisle) to the front panel (hot aisle).

Figure 24: Install the Chassis in the Rack



1	Rack-mount bracket	2	Rack-mount bracket
3	Cold aisle Chassis I/O side (rear panel)	4	Hot aisle Chassis non-I/O side (front panel)
5	Air flow direction (I/O side to non-I/O side)		—

**What to do next**

You can now install the cables and power cord, as described in the [Cisco Firepower 1100 Getting Started Guide](#).







## CHAPTER 4

# Connect to the Console Port

---

- [Connect to the Console Port with Microsoft Windows, on page 29](#)
- [Connect to the Console Port with Mac OS X, on page 31](#)
- [Connect to the Console Port with Linux, on page 31](#)

## Connect to the Console Port with Microsoft Windows

You must install a USB device driver the first time a Microsoft Windows-based PC is connected to the USB console port on the chassis, otherwise the connection fails.

To uninstall the driver, use the Add Remove Programs utility or the Setup-exe program.



---

**Note** Disconnect the console terminal before uninstalling the driver.

---

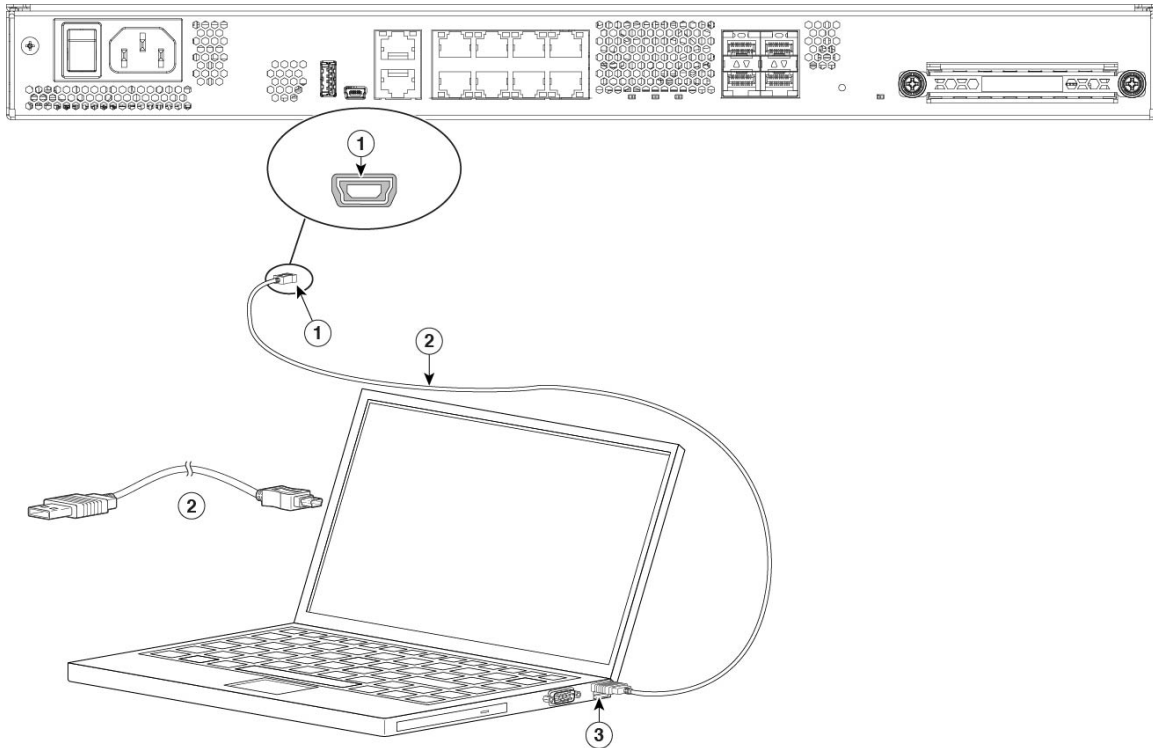
**Step 1** Obtain the appropriate driver (Cisco\_usbconsole\_driver\_X\_X\_zip, where X is a revision number) for your model from the Cisco [Download Software](#) site, USB Console Software category.

**Note** The download site redirects you to a router download section where the drivers are also applicable to Firepower products. The drivers are OS-specific and not tied to the vendor of the console cable manufacturer.

**Step 2** Install the driver.

**Step 3** Connect a 5-pin USB Mini B to the console port as shown in the following figure.

Figure 25: Console Port Connection



1	USB Mini B console port	2	USB Mini B to USB Type A console cable
3	USB Type A		—

**Step 4** Connect the end of the cable with the DB-9 connector (or USB Type A) to the terminal or PC. If your terminal or PC has a console port that does not accommodate a DB-9 connector, you must provide an appropriate adapter for that port. The LED for the console port turns green and within a few moments the Found New Hardware Wizard appears.

**Step 5** Follow the instructions to complete the driver installation.

**Step 6** To communicate with the chassis, start a terminal emulator application. This software should be configured with the following parameters:

- 9600 baud
- 8 data bits
- no parity
- 1 stop bit
- no flow control

## Connect to the Console Port with Mac OS X

Follow these steps to connect a Mac OS X system USB port to the console using the built-in OS X Terminal utility, or alternatively you can use a separate terminal emulator application.

---

**Step 1** Use the Finder to go to **Applications > Utilities > Terminal**.

**Step 2** Connect the OS X USB port to the chassis.

**Step 3** Enter the following commands to find the OS X USB port number:

**Example:**

```
macbook:user$ cd /dev
macbook:user$ ls -ltr /dev/*usb*
crw-rw-rw- 1 root wheel 9, 66 Apr 1 16:46 tty.usbmodem1a21
DT-macbook:dev user$
```

**Step 4** Connect to the USB port with the following command followed by the chassis USB port speed:

**Example:**

```
macbook:user$ screen /dev/tty.usbmodem1a21 9600
```

**Step 5** Enter **Ctrl-a** followed by **d** to disconnect the OS X USB console from the Terminal window.

---

## Connect to the Console Port with Linux

Follow these steps to connect a Linux system USB port to the console using the built-in Linux Terminal utility.

---

**Step 1** Open the Linux Terminal window.

**Step 2** Connect the Linux USB port to the chassis.

**Step 3** Enter the following commands to find the Linux USB port number:

**Example:**

```
root@usb-suse# cd /dev
root@usb-suse /dev# ls -ltr *ACM*
crw-r--r-- 1 root root 188, 0 Jan 14 18:02 ttyACM0
root@usb-suse /dev#
```

**Step 4** Connect to the USB port with the following command followed by the chassis USB port speed

**Example:**

```
root@usb-suse /dev# screen /dev/ttyACM0 9600
```

**Step 5** To disconnect the Linux USB console from the Terminal window, enter **Ctrl-a** followed by **:** then **quit**.

---





## CHAPTER 5

# Installation, Maintenance, and Upgrade

---

- [Replace the SSD, on page 33](#)
- [Install the FIPS Opacity Shield in a Two-Post Rack, on page 34](#)

## Replace the SSD

The Firepower 1100 ships with an SSD installed. You can replace this SSD should it fail. Before replacing the SSD, you must power off the chassis by pressing the power switch on the rear panel.



---

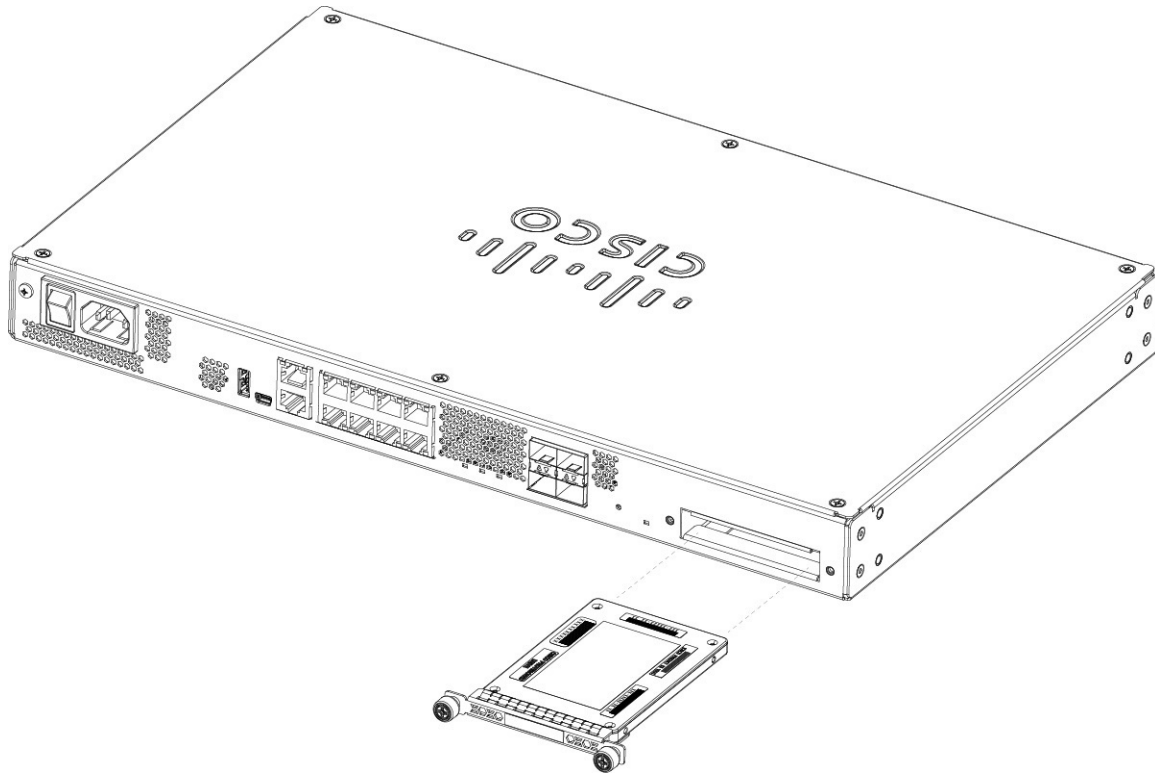
**Caution** You will lose your configuration after you replace the existing SSD with a new SSD.

---

Follow these steps to replace an SSD in the chassis:

- 
- Step 1** Loosen the thumb screws on both sides of the SSD bay and pull the existing SSD out of the bay.
- Step 2** Insert the new SSD into the bay and push it in until it is seated.

Figure 26: Remove and Install an SSD



**Step 3** Tighten the thumb screws on both sides of the SSD bay.

**Step 4** Check the SSD LED to make sure the SSD is seated properly and functioning. See [Rear Panel LEDs](#), on page 9 for a description of the SSD LED.

## Install the FIPS Opacity Shield in a Two-Post Rack



**Note** Because the FIPS opacity shield covers the serial number on the chassis, the CO should copy the serial number and store it in a secure place. The serial number is needed when you call Cisco TAC.

### Before you begin



**Caution** This procedure should be performed only by the Crypto Officer (CO).

You need the following items to install the FIPS opacity shield:

- #1 Phillips screwdriver
- The following items from the FIPS kit (part number 800-105495-01):

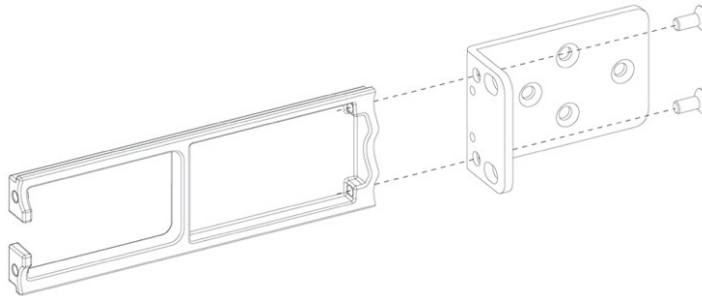
- One FIPS opacity shield (part number 69-100612-01)
- Two cable management brackets (part number 700-117013-01)
- Eight Phillips 8-32 x 0.375-inch screws (part number 48-0629-01) used to attach the FIPS opacity shield to the cable management brackets
- Ten Tamper Evidence Labels (TEL) (part number 47-25553-01)



**Note** The TELs are made of a special thin gauge vinyl with self-adhesive backing. Once the CO attaches them on the chassis, any attempt to open the chassis damages the TELs or the chassis cover. Because the TELs have nonrepeated serial numbers, the CO can inspect them for damage and compare them against the applied serial numbers to verify whether the chassis has been tampered with. TELs with curled corners, rips, and slices indicate tampering. The word “FIPS” or “OPEN” may appear if the label has been peeled back.

- Step 1** Copy the serial number and store in a secure place. To find the serial number, see [Serial Number Location](#).
- Step 2** Perform the Step 1 as described in [Rack-Mount the Chassis, on page 25](#).
- Step 3** Install the cable management brackets.

**Figure 27: Install the Cable Management Screws into the Rack-Mount Bracket**



- Step 4** Connect the cables to the ports. Make sure that the cables have enough slack to route them through the cable mounting brackets.

**Note** If you are installing the FIPS opacity shield after the initial product installation, the cables are connected. If the attached cables do not have enough slack to route them through the cable mounting brackets (as shown in the figure below), you will have to turn the power off on the appliance, remove the cables, route the cables through the cable mounting brackets, reattach the cables, and continue with Step 5 below.

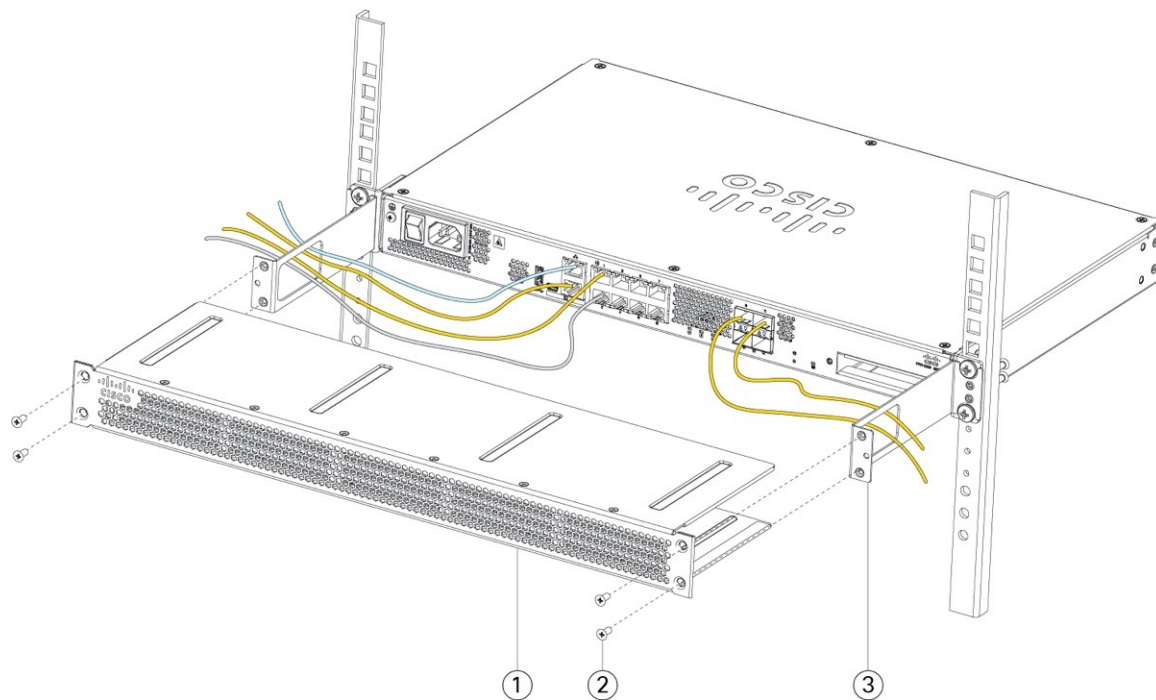
**Note** When you toggle the power switch from ON to OFF, it takes several seconds for the system to power down. Do not remove the power cable until the power LED is off. After removing power from the chassis either by moving the power switch to OFF or unplugging the power cord, wait at least 10 seconds before turning power back ON.

## Install the FIPS Opacity Shield in a Two-Post Rack

**Step 5** Route the cables through the openings in the cable management brackets as shown in the figure below.

**Step 6** Attach the FIPS opacity shield to the cable management brackets using four of the 8-32 x 0.375-inch Phillips screws provided in the FIPS kit as shown in the figure below.

**Figure 28: Install the FIPS Cover**



1	FIPS opacity shield	2	8-32 x 0.375-inch Phillips screws (two per side)
3	Cable management bracket		—

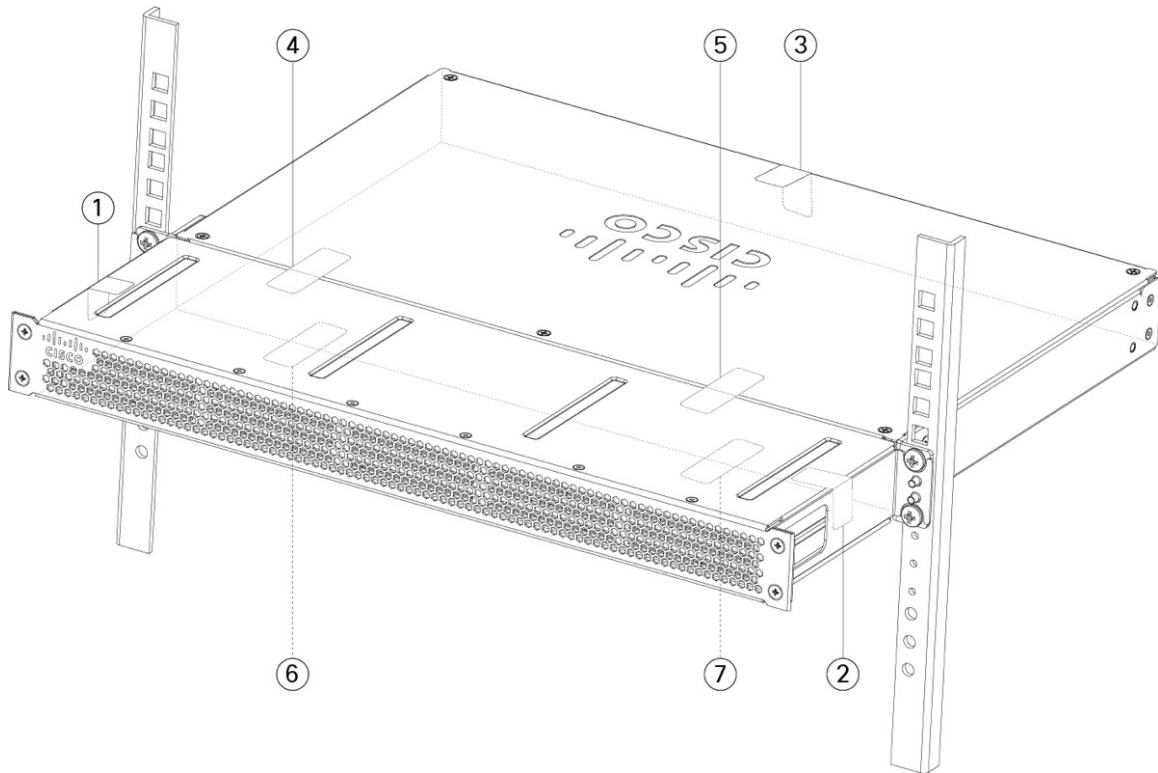
**Step 7** Before you attach the TELs, clean the chassis and FIPS cover of any grease, dirt, or oil with alcohol-based cleaning pads .

**Step 8** Attach seven of the TELs. See the figure below for the correct placement. Allow the TELs to cure for a minimum of 12 hours.

**Caution** Any deviation in the placement of the TELs means the chassis is not in FIPS mode.



Figure 29: TELs Placement on the Chassis



1	TEL 1 on the left side and top of chassis	2	TEL 2 on the right side and top of chassis
3	TEL 3 on the top and back of chassis	4	TEL 4 across the FIPS shield and the chassis (towards the left of the chassis)
5	TEL 5 across the FIPS shield and the chassis (towards the right of the chassis)	6	TEL 6 on the bottom of the chassis towards the left side of the chassis
7	TEL 7 on the bottom of the chassis towards the right side of the chassis		—

**Step 9** Attach the power cable to the chassis and connect it to an electrical outlet.

**Step 10** Press the power switch on the rear panel.

**Step 11** Check the power LED on the front panel. See [Rear Panel LEDs, on page 9](#) for a description of the power LED. Solid green indicates that the chassis is powered on.

**Step 12** Place the chassis in FIPS mode.

See the following procedures for how to place the chassis in FIPS mode:

- [ASA in Platform Mode](#)
- [ASA in Appliance mode](#)

- [FTD managed by FMC](#)
- 

**What to do next**

See the [Cisco Firepower 1100 Getting Started Guide](#) for further configuration information.